

# Technical Data Sheet

Wall Support - Heavy Duty Mounting Angle  
Hot Dip Galvanized According To EN ISO 1461



## Master Data

Product Code	078.SA100300
Description 1	Wall Support
Description 2	Heavy Duty Mounting Angle
Dimension	100 x 300mm
Material	Steel
Surface Protection	Hot Dip Galvanized Steel According To EN ISO 1461
Use	Outdoor / Wet Indoor Facilities
F in KN	0.75 KN

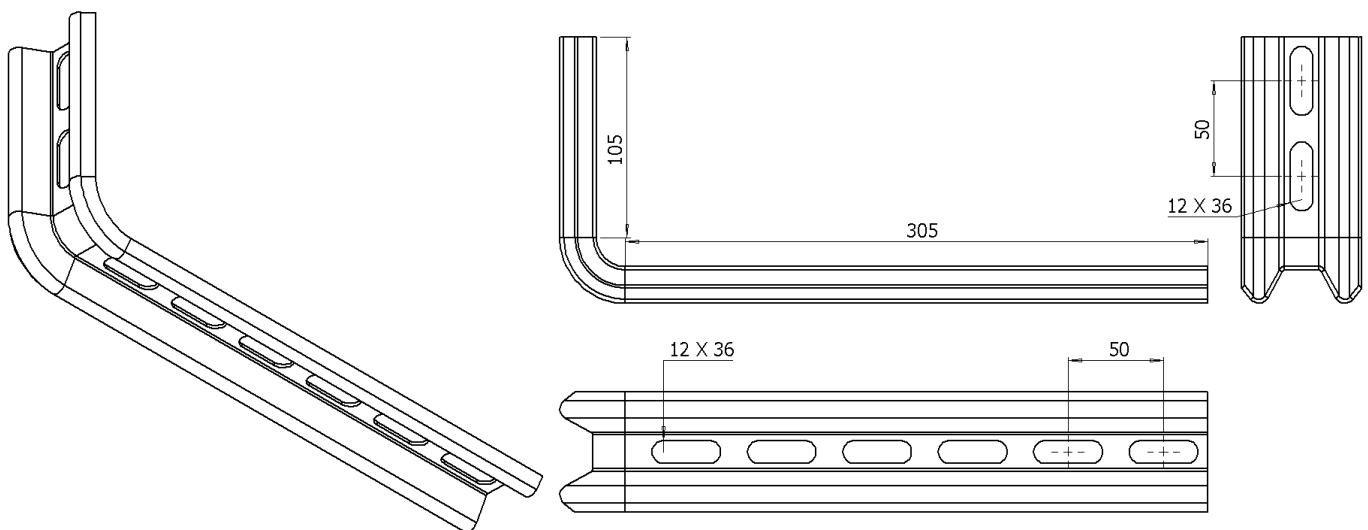

ISO 9001:2015